

## Twig Lite

PROJECT:
TYPE:
SOURCE:
NOTES:

### PURELED SPECIFICATIONS

<b>LED Chip</b>	Cree XPG-3 Plug and Play field replaceable LED board
<b>Luminaire Output</b>	120 Lumens @ 700mA (2 watts), delivered from luminaire with unobstructed beam.
<b>Lumens Per Watt</b>	60 Lumens minimum @ 2 watts, delivered from luminaire with unobstructed beam
<b>CRI (3000K)</b>	90+
<b>Colour Temperatures</b>	2700K, 3000K, 4000K
<b>Beam Angles</b>	Asymmetric
<b>Ingress Protection</b>	IP44

<b>Warranty</b>	Electronics = 5 years Body Cop/SS = 10 years
<b>Standards</b>	AS/NZS 61046 cUL 1838, 2108 CSA C22.2 No.250.7, No.250.0-08 CE

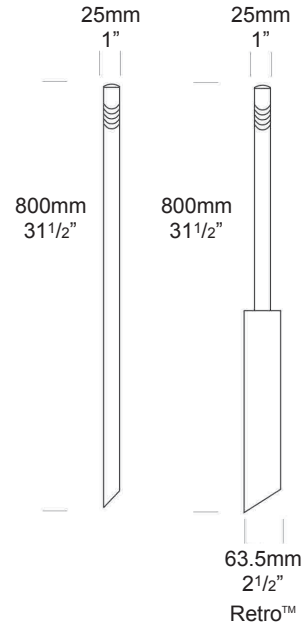

### PRODUCT CONFIGURATION

Please fill in appropriate codes into boxes provided

Cat. No. TG/L

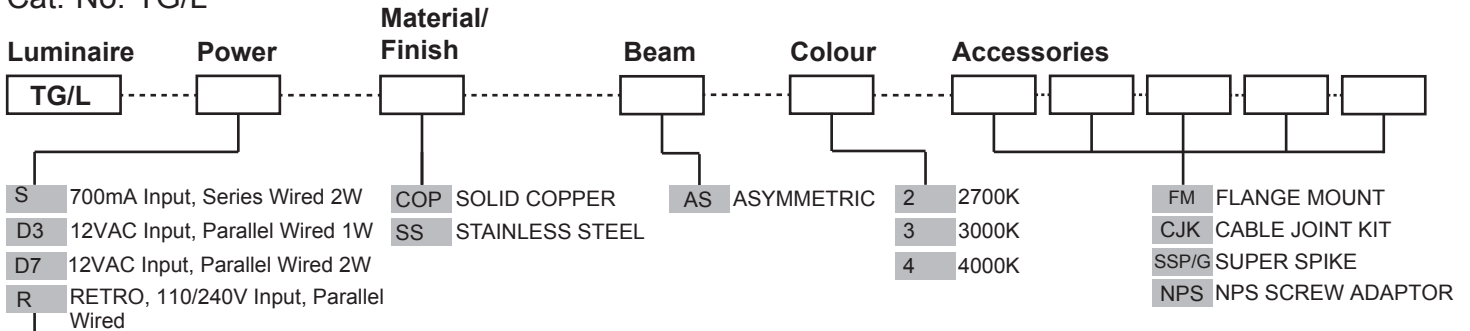

**SERIES, REMOTE DRIVER REQUIRED:**  
Constant current driver  
Individual fixtures require 3vdc @ 700mA maximum  
**12VAC INTEGRAL DRIVER:**  
Hunza Buckbullet driver (included)  
Input: 12VAC, 2watt total  
Output: 3vdc @ D3=350mA, D7=700mA  
**110/240VAC RETRO DRIVER:**  
Input: 120/240vac, 2 watt total (included)  
Output: 3vdc, 700mA (non dimming)

**OTHER LAMP OPTIONS**  
TG /GL - G4 LED Retrofit 12V Lamp (lamps vary by market - please refer to supplier for details)

[Click here for 240v Remote Power Supply Guidance Charts](#)  
[Click here for USA Remote Power Supply Guidance Charts](#)

# LUMINAIRE CONSTRUCTION

## CNC machined from one of the following

### metals:

#### Copper

Pole: solid copper 25.4mm (1") rod.  
End cap: solid copper 25.4mm (1") rod.

#### 316 Stainless Steel

Pole: 316 stainless steel 25.4mm (1") rod.  
End cap: 316 stainless steel 25.4mm (1") rod.

### Lens:

22mm (3/4") extra clear low iron flush fit shatter resistant glass tube.  
Lifetime warranty.

### Gaskets:

Silicone, iron impregnated 220°C (428°F).

### Mounting

The pole 800mm (31½") is directly mounted into the earth or concrete. For extra stability in sand or loose ground use the Super Spike. Flange Mount option is available for hard surfaces.

### Luminaire Weight:

Low voltage  
Cop: 0.800kg (1lb 12oz)  
SS: 0.800kg (1lb 12oz)  
Retro™  
Cop: 1.980kg (4lb 6oz)  
SS: 1.980kg (4lb 6oz)

## ACCESSORIES

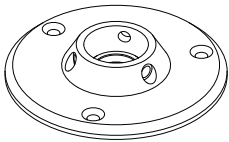

Flange Mount

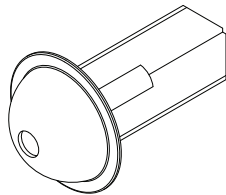

Super Spike

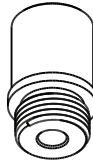

NPS 1/2"  
Screw Mount Adaptor

## BEAM ANGLES

High efficiency PMMA TIR lenses. Field replaceable

IES files available for download: [hunzalighting.com/downloads](http://hunzalighting.com/downloads)

## WIRING GUIDE

### Series/remote driver

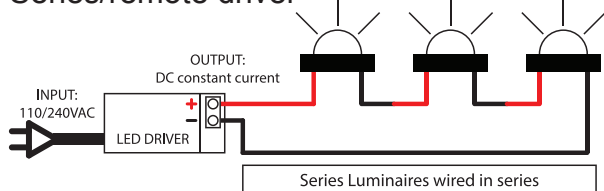

Diagrams are a guide only, wire colours and polarity may change depending on fixture and country

Available for download: [hunzalighting.com/downloads](http://hunzalighting.com/downloads)

### 12v integral driver

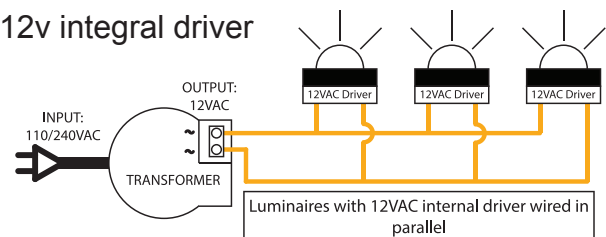

Specifications may change without notification

Aug 2017

**HUNZA**™ PURE  
OUTDOOR  
LIGHTING

### HUNZA FACTORY

130 Felton Mathew Ave  
Saint Johns  
Auckland 1072  
New Zealand

Ph: +64-9-528 9471  
Fax: +64-9-528 9361  
hunza@hunza.co.nz  
www.hunzalighting.com

### INTERNATIONAL CONTACTS:

<http://www.hunzalighting.com/contact.php>

This document contains proprietary information of Hunza. Its receipt or possession does not convey any rights to reproduce or disclose its content.