

[product.]

1G-4G TOGGLE SWITCHES

[knurl. **CROSS.**]

[range. **ELECTRICITY.**]

[region. **UK.**]

A toggle switch made from solid metal with a diamond-cut knurled knob to feel amazing with every touch. The switch is finished with a flat plate and our signature solid metal penny buttons. Available in 12 different metal combinations. You can also team them up with our dimmers, plug sockets and euro plates in matching finishes.



[type. **1G TOGGLE SWITCH.**]

[info. **MEASUREMENTS.**]

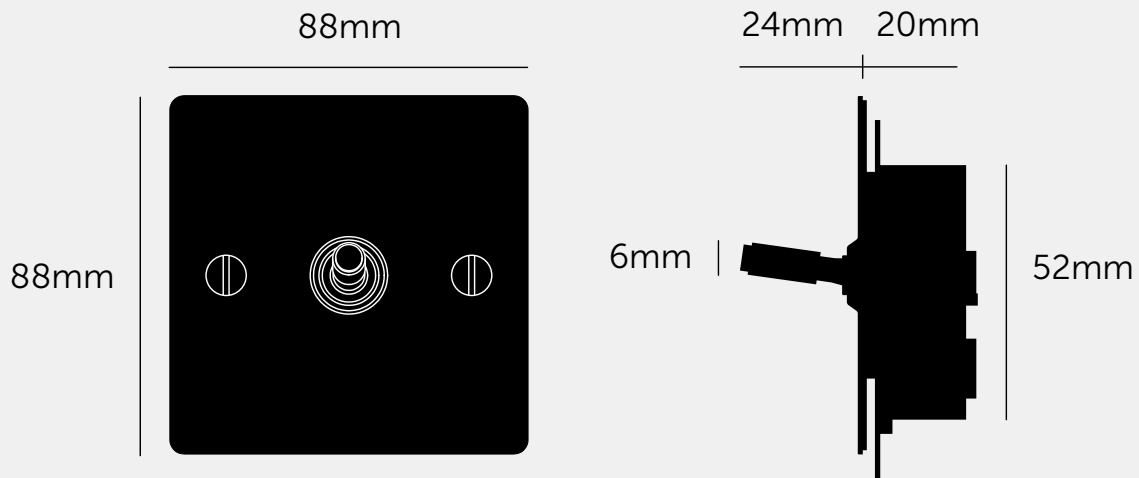

[info. **SPECIFICATIONS.**]

Single switch 2-way













10 AX

240 V

CE-tested for use throughout Europe.

[info. **FINISH & SKU NUMBERS.**]

[finish.]

-  White
-  White / Steel
-  White / Brass
-  Steel
-  Steel / Brass
-  Brass
-  Smoked Bronze
-  Smoked Bronze / Steel
-  Smoked Bronze / Brass
-  Black
-  Black / Steel
-  Black / Brass

[UK.]

- UK-TO-CO-1G-WH-A
- UK-TO-CO-1G-WH-ST-A
- UK-TO-CO-1G-WH-BR-A
- UK-TO-CO-1G-ST-A
- UK-TO-CO-1G-ST-BR-A
- UK-TO-CO-1G-BR-A
- UK-TO-CO-1G-SM-A
- UK-TO-CO-1G-SM-ST-A
- UK-TO-CO-1G-SM-BR-A
- UK-TO-CO-1G-BL-A
- UK-TO-CO-1G-BL-ST-A
- UK-TO-CO-1G-BL-BR-A

[info. **INCLUDED.**]

1 x 1G TOGGLE SWITCH

[info. **RECOMMENDED.**]

Back Box

1G square back box - 47mm depth Can be supplied on request

[info. **CARE INSTRUCTIONS.**]

Wipe with damp cloth with no loose hairs, avoid using any chemicals. All finishes are prone to aging.

[please. **NOTE.**]

DISCLAIMER: Always consult a trade professional when installing these 1G Toggle Switch. Buster + Punch is not responsible for the usage or feasibility of installation requirements. This product is not suitable for damp or wet environments.

[type. **2G TOGGLE SWITCH.**]

[info. **MEASUREMENTS.**]

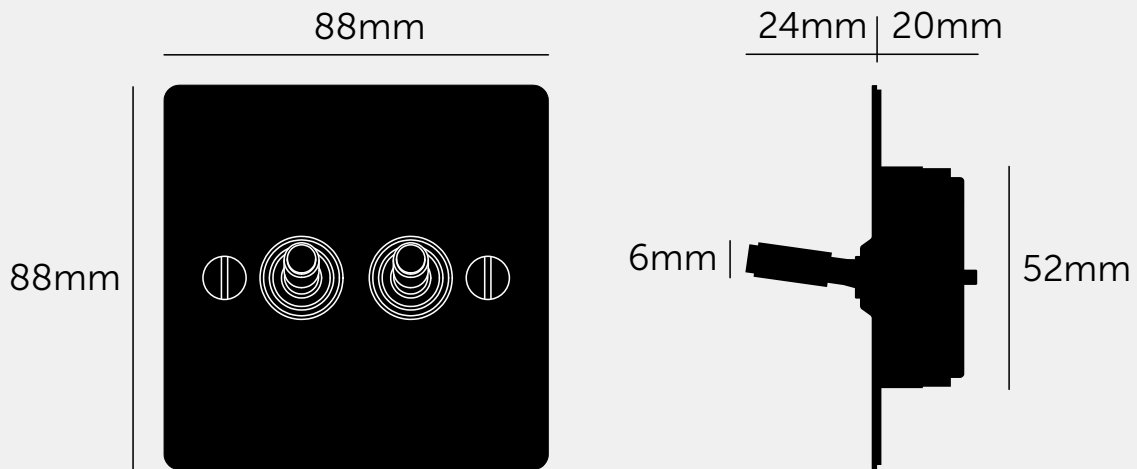

[info. **SPECIFICATIONS.**]

Double switch 2-way













10 AX

240 V

CE-tested for use throughout Europe.

[info. **FINISH & SKU NUMBERS.**]

[finish.]

-  White
-  White / Steel
-  White / Brass
-  Steel
-  Steel / Brass
-  Brass
-  Smoked Bronze
-  Smoked Bronze / Steel
-  Smoked Bronze / Brass
-  Black
-  Black / Steel
-  Black / Brass

[UK.]

- UK-TO-CO-2G-WH-A
- UK-TO-CO-2G-WH-ST-A
- UK-TO-CO-2G-WH-BR-A
- UK-TO-CO-2G-ST-A
- UK-TO-CO-2G-ST-BR-A
- UK-TO-CO-2G-BR-A
- UK-TO-CO-2G-SM-A
- UK-TO-CO-2G-SM-ST-A
- UK-TO-CO-2G-SM-BR-A
- UK-TO-CO-2G-BL-A
- UK-TO-CO-2G-BL-ST-A
- UK-TO-CO-2G-BL-BR-A

[info. **INCLUDED.**]

1 x 2G TOGGLE SWITCH

[info. **RECOMMENDED.**]

Back Box

1G square back box - 47mm depth Can be supplied on request

[info. **CARE INSTRUCTIONS.**]

Wipe with damp cloth with no loose hairs, avoid using any chemicals. All finishes are prone to aging.

[please. **NOTE.**]

DISCLAIMER: Always consult a trade professional when installing these 2G Toggle Switch. Buster + Punch is not responsible for the usage or feasibility of installation requirements. This product is not suitable for damp or wet environments.

[type. **3G TOGGLE SWITCH.**]

[info. **MEASUREMENTS.**]

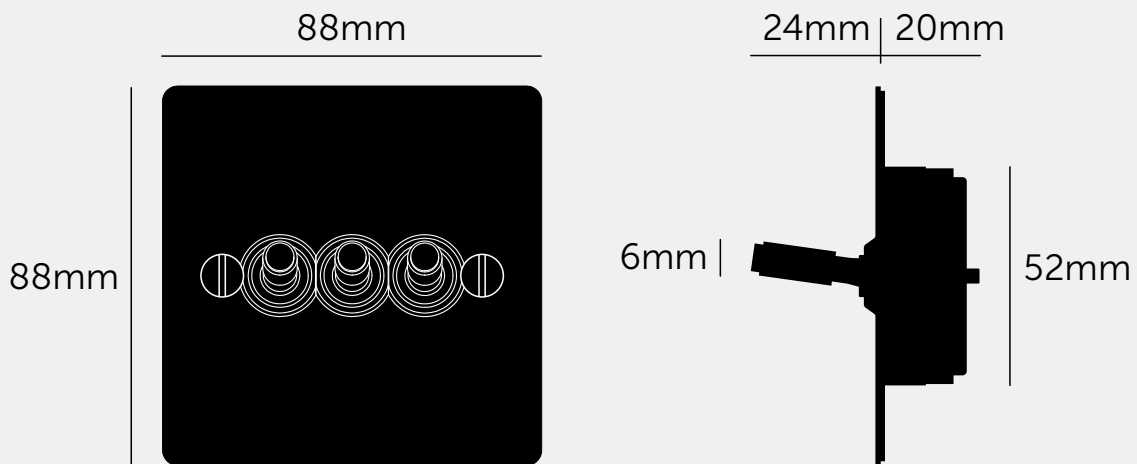

[info. **SPECIFICATIONS.**]

Triple switch 2-way













10 AX

240 V

CE-tested for use throughout Europe.

[info. **FINISH & SKU NUMBERS.**]

[finish.]

-  White
-  White / Steel
-  White / Brass
-  Steel
-  Steel / Brass
-  Brass
-  Smoked Bronze
-  Smoked Bronze / Steel
-  Smoked Bronze / Brass
-  Black
-  Black / Steel
-  Black / Brass

[UK.]

- UK-TO-CO-3G-WH-A
- UK-TO-CO-3G-WH-ST-A
- UK-TO-CO-3G-WH-BR-A
- UK-TO-CO-3G-ST-A
- UK-TO-CO-3G-ST-BR-A
- UK-TO-CO-3G-BR-A
- UK-TO-CO-3G-SM-A
- UK-TO-CO-3G-SM-ST-A
- UK-TO-CO-3G-SM-BR-A
- UK-TO-CO-3G-BL-A
- UK-TO-CO-3G-BL-ST-A
- UK-TO-CO-3G-BL-BR-A

[info. **INCLUDED.**]

1 x 3G TOGGLE SWITCH

[info. **RECOMMENDED.**]

Back Box

1G square back box - 47mm depth Can be supplied on request

[info. **CARE INSTRUCTIONS.**]

Wipe with damp cloth with no loose hairs, avoid using any chemicals. All finishes are prone to aging.

[please. **NOTE.**]

DISCLAIMER: Always consult a trade professional when installing these 3G Toggle Switch. Buster + Punch is not responsible for the usage or feasibility of installation requirements. This product is not suitable for damp or wet environments.

[type. **4G TOGGLE SWITCH.**]

[info. **MEASUREMENTS.**]

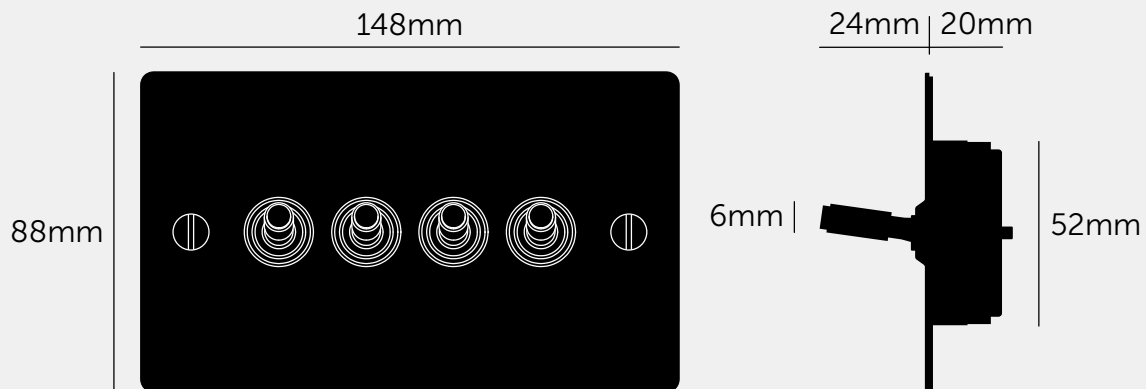

[info. **SPECIFICATIONS.**]

Quadruple switch 2-way

10 AX

240 V

CE-tested for use throughout Europe.

[info. **FINISH & SKU NUMBERS.**]

[finish.]

[UK.]

● White	UK-TO-CO-4G-WH-A
● White / Steel	UK-TO-CO-4G-WH-ST-A
● White / Brass	UK-TO-CO-4G-WH-BR-A
● Steel	UK-TO-CO-4G-ST-A
● Steel / Brass	UK-TO-CO-4G-ST-BR-A
● Brass	UK-TO-CO-4G-BR-A
● Smoked Bronze	UK-TO-CO-4G-SM-A
● Smoked Bronze / Steel	UK-TO-CO-4G-SM-ST-A
● Smoked Bronze / Brass	UK-TO-CO-4G-SM-BR-A
● Black	UK-TO-CO-4G-BL-A
● Black / Steel	UK-TO-CO-4G-BL-ST-A
● Black / Brass	UK-TO-CO-4G-BL-BR-A

[info. **INCLUDED.**]

1 x 4G TOGGLE SWITCH

[info. **RECOMMENDED.**]

Back Box

1G square back box - 47mm depth Can be supplied on request

[info. **CARE INSTRUCTIONS.**]

Wipe with damp cloth with no loose hairs, avoid using any chemicals. All finishes are prone to aging.

[please. **NOTE.**]

DISCLAIMER: Always consult a trade professional when installing these 4G Toggle Switch. Buster + Punch is not responsible for the usage or feasibility of installation requirements. This product is not suitable for damp or wet environments.

[type. **TOGGLE SWITCH.**]

[info. **FAQ SHEET.**]

CATEGORY	QUESTION	ANSWER
GENERAL	How do I clean my electricity collection?	A slight damp microfiber cloth is best, never use any chemicals as this will damaged the metal surface.
BACK BOXES	What size back boxes do you recommend?	1G: W 70mm x H 70mm x D 47mm, square back box. 2G: W 140mm x H 70mm x D 47mm, square back box Back boxes can be supplied on request.
TOGGLE	Are your toggles 2 way or 3 way?	All our toggles are 2 ways. We also supply intermediate switches in 1G only which are 3 way.
TOGGLE	Are the toggles available as dimmers?	No, unfortunately they are not.
TOGGLE	Can we remove and replace the toggle on the plate?	No, the toggles are fixed to the plate and are unable to be removed.
TOGGLE	Do you manufacture / stock spring loaded toggles?	No, unfortunately we don't.
TOGGLE	Can I mix a toggle switches with a dimmer?	No, unfortunately this is not possible.
TOGGLE	Can I put an intermediate on a 2G plate?	No, unfortunately this is not possible.
TOGGLE	Are your toggles switches dimmable?	No, unfortunately this is not possible.
TOGGLE	The spring action has gone in my toggle?	Please contact Buster + Punch for any faulty product. Please supply photos or videos.